

KOMPOZİT / COMPOSITE

KOMPOZİT PANEL PROFİLLERİ COMPOSITE PANEL PROFILES

731

KONVANSİYONEL / CONVENTIONAL

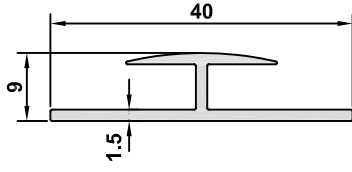
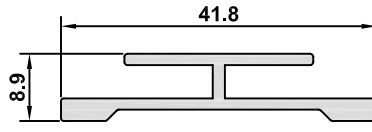
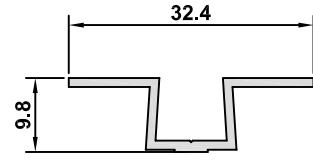
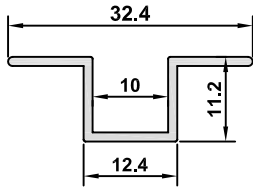
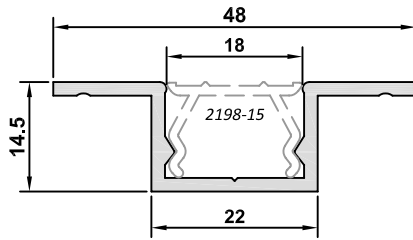
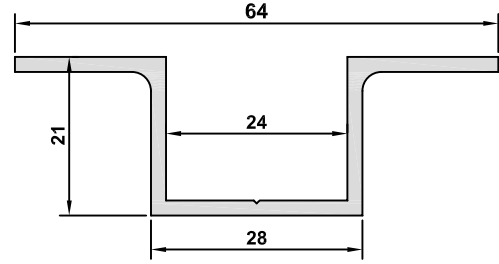
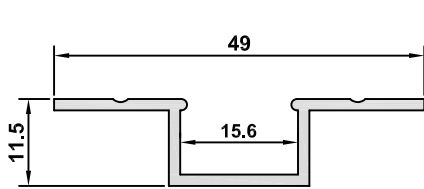
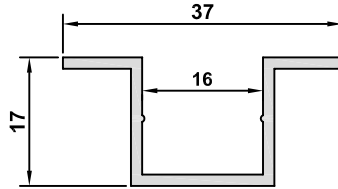
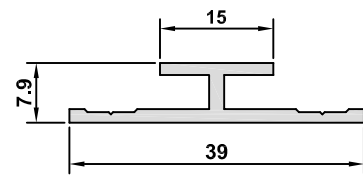
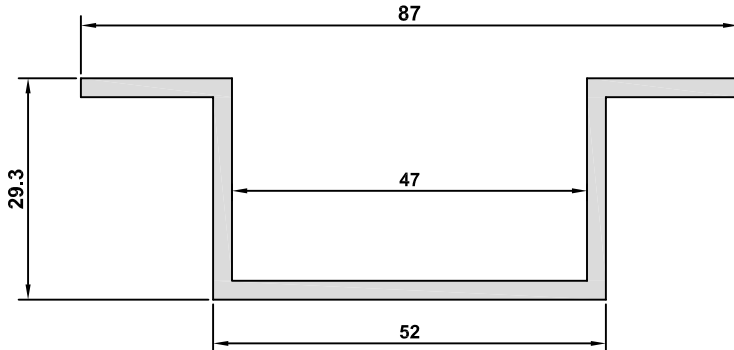
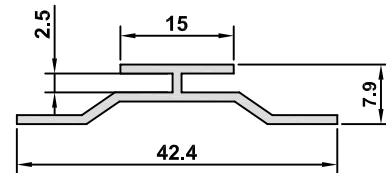

KOMPOZİT / COMPOSITE

**5959-1.5**AĞIRLIK / WEIGHT
0,250 kg/m**5201-1.5**AĞIRLIK / WEIGHT
0,344 kg/m**3078-1.2**AĞIRLIK / WEIGHT
0,168 kg/m**2651-1.2**AĞIRLIK / WEIGHT
0,171 kg/m**4482-1.8**AĞIRLIK / WEIGHT
0,371 kg/m**4481-2.0**AĞIRLIK / WEIGHT
0,561 kg/m**5961-1.5**AĞIRLIK / WEIGHT
0,285 kg/m**5021-1.5**AĞIRLIK / WEIGHT
0,280 kg/m**6896-16**AĞIRLIK / WEIGHT
0,266 kg/m**4627-2.5**AĞIRLIK / WEIGHT
0,955 kg/m**5259**AĞIRLIK / WEIGHT
0,205 kg/m

KOMPOZİT / COMPOSITE

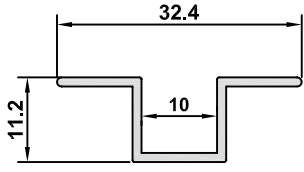

2651-12
AĞIRLIK / WEIGHT
0,171 kg/m

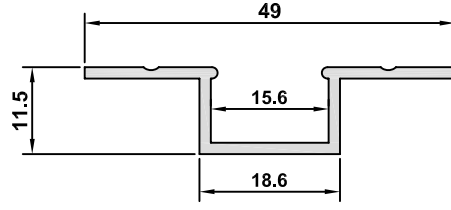

5061-15
AĞIRLIK / WEIGHT
0,285 kg/m

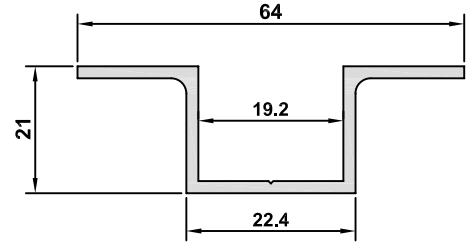

4481-20
AĞIRLIK / WEIGHT
0,561 kg/m

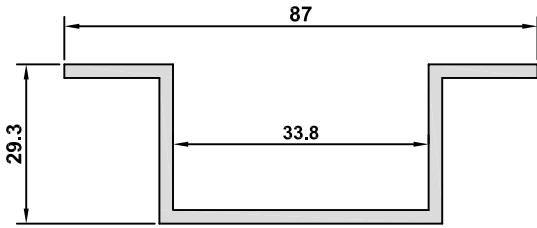

4627-25
AĞIRLIK / WEIGHT
0,955 kg/m

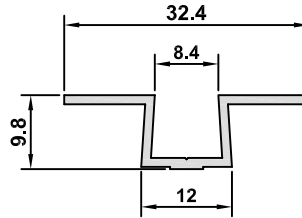

3078-12
AĞIRLIK / WEIGHT
0,168 kg/m

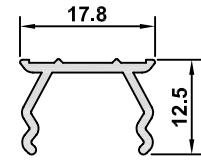

2198-15
AĞIRLIK / WEIGHT
0,140 kg/m

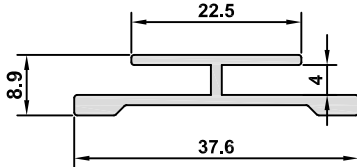

5204-15
AĞIRLIK / WEIGHT
0,344 kg/m

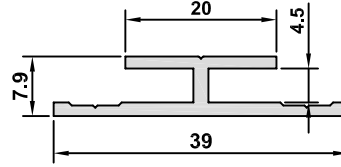

6869-18
AĞIRLIK / WEIGHT
0,284 kg/m

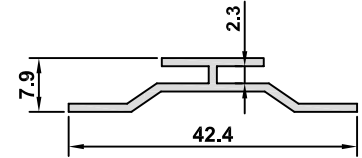

5259-12
AĞIRLIK / WEIGHT
0,205 kg/m

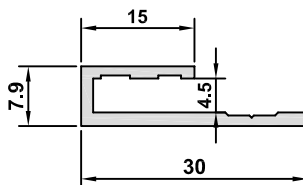

4995-1.6
AĞIRLIK / WEIGHT
0,217 kg/m

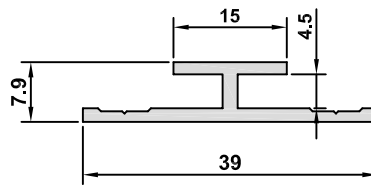

4993-1.6
AĞIRLIK / WEIGHT
0,266 kg/m

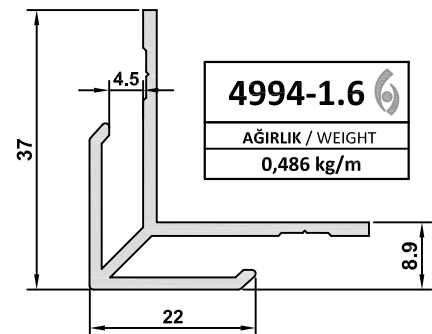

4994-1.6
AĞIRLIK / WEIGHT
0,486 kg/m